

SECTION A-A
SCALE: 1"=10'

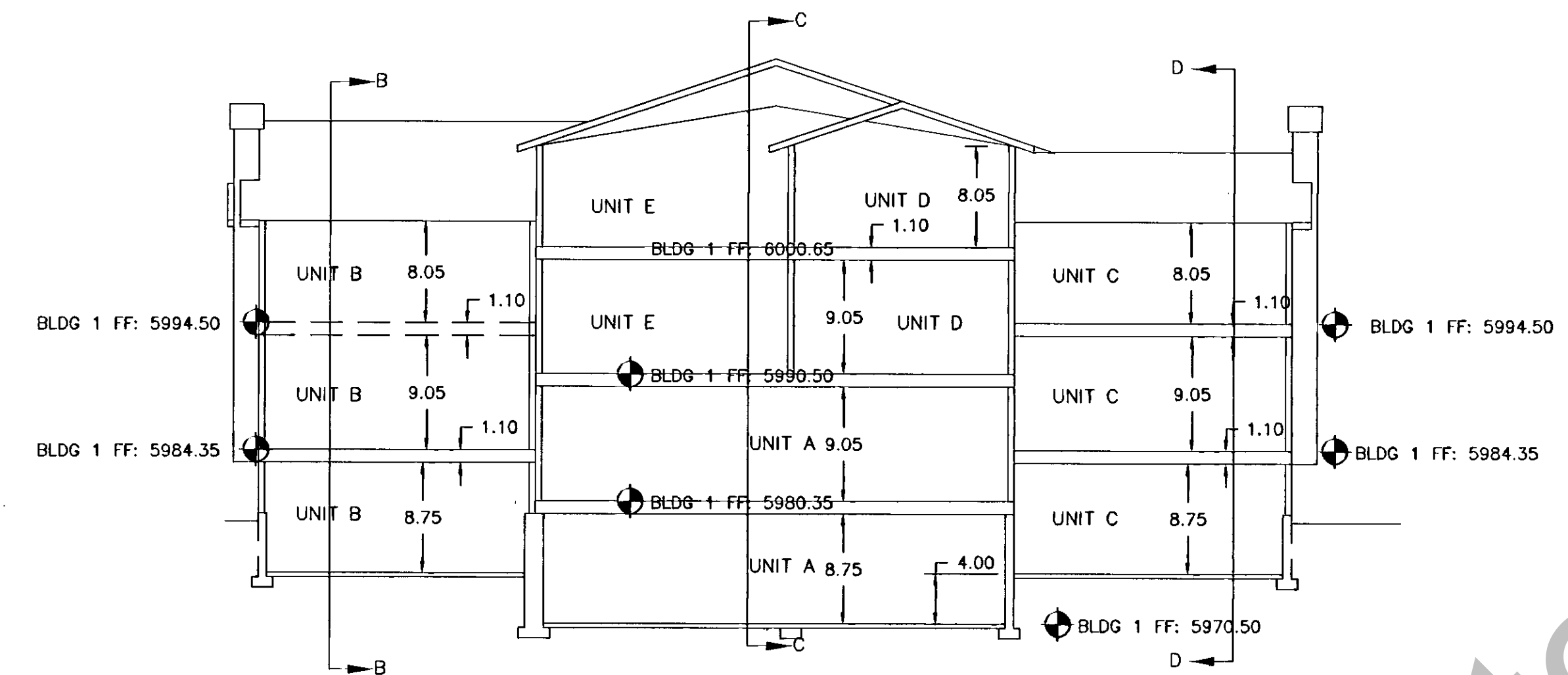

SECTION A2-A2
SCALE: 1"=10'

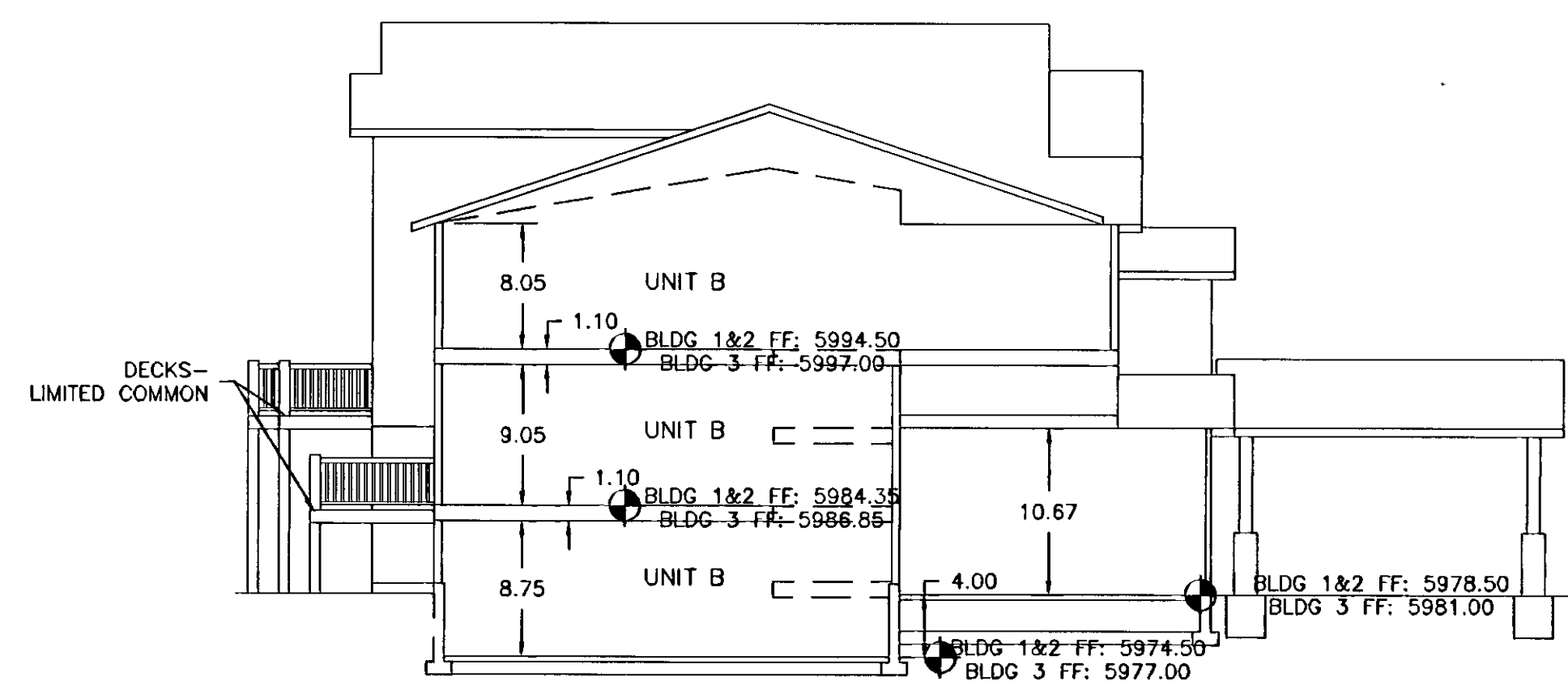

SECTION B-B
SCALE: 1"=10'

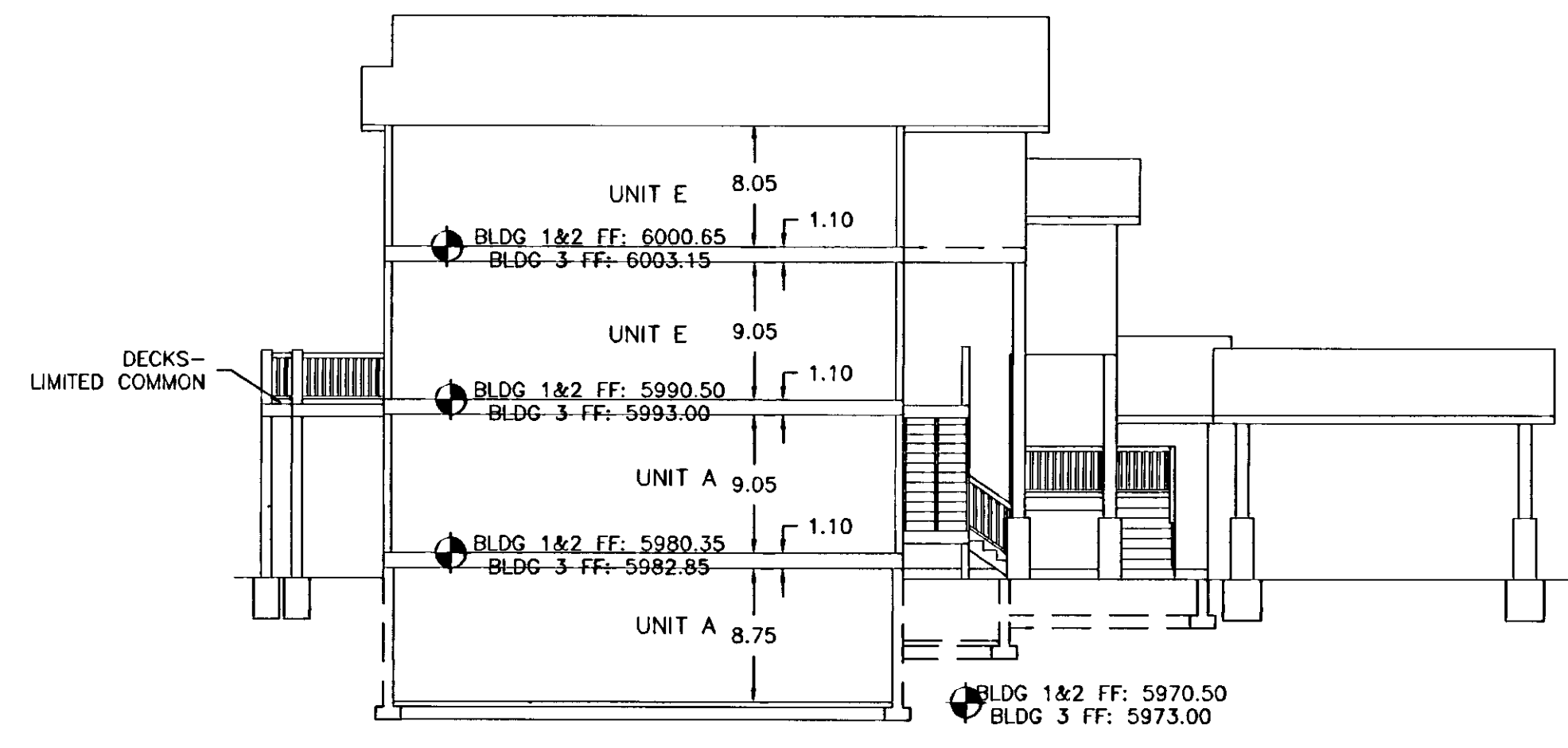

SECTION C-C
SCALE: 1"=10'

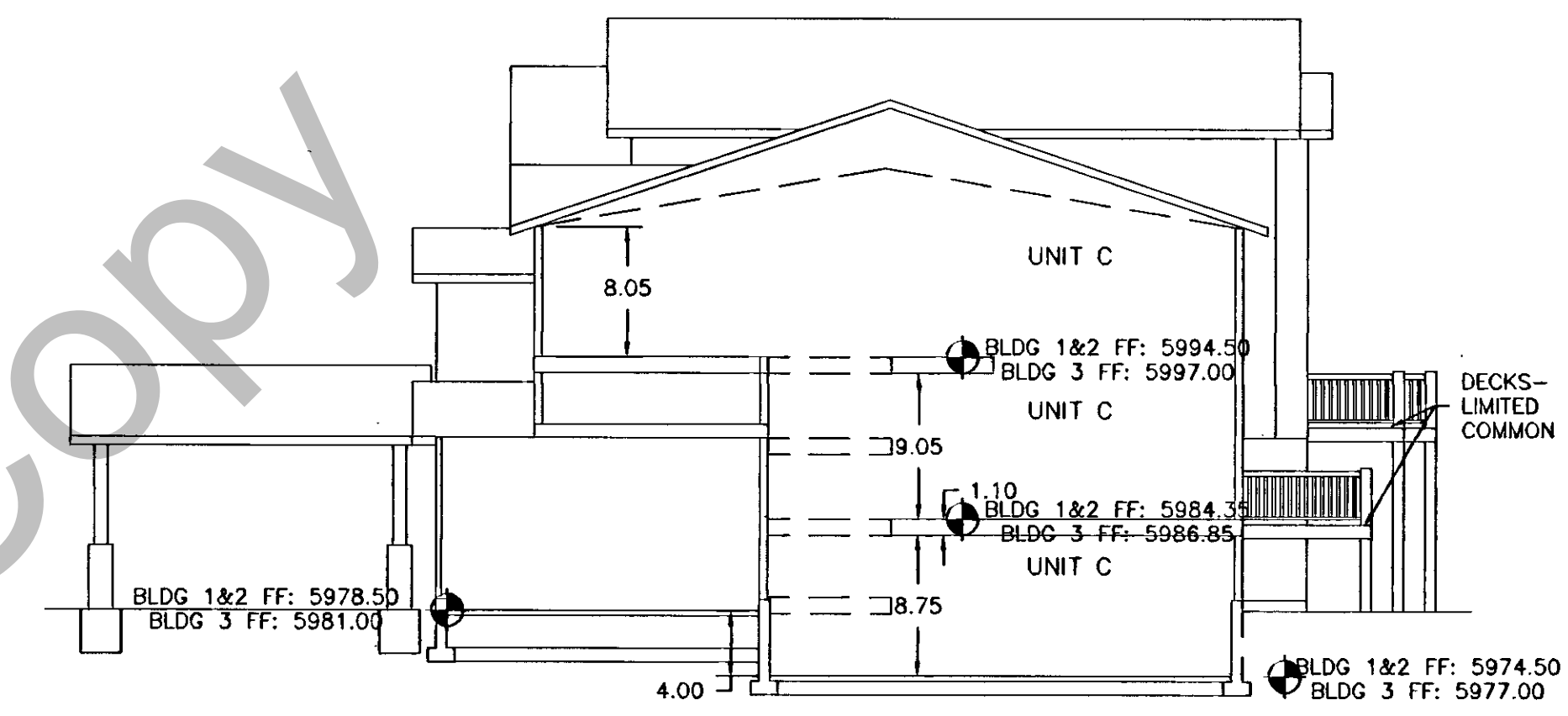

SECTION D-D
SCALE: 1"=10'

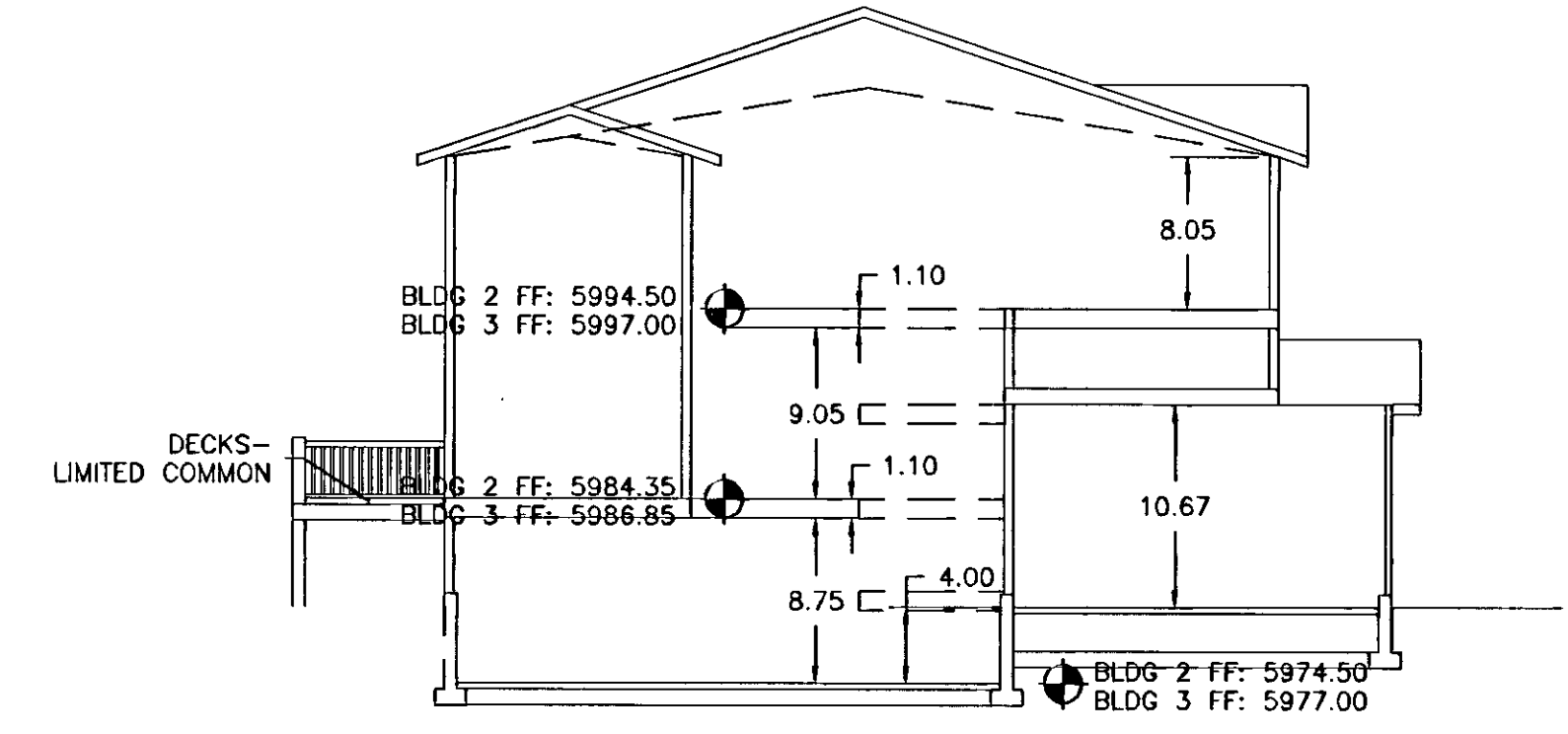

SECTION E-E
SCALE: 1"=10'

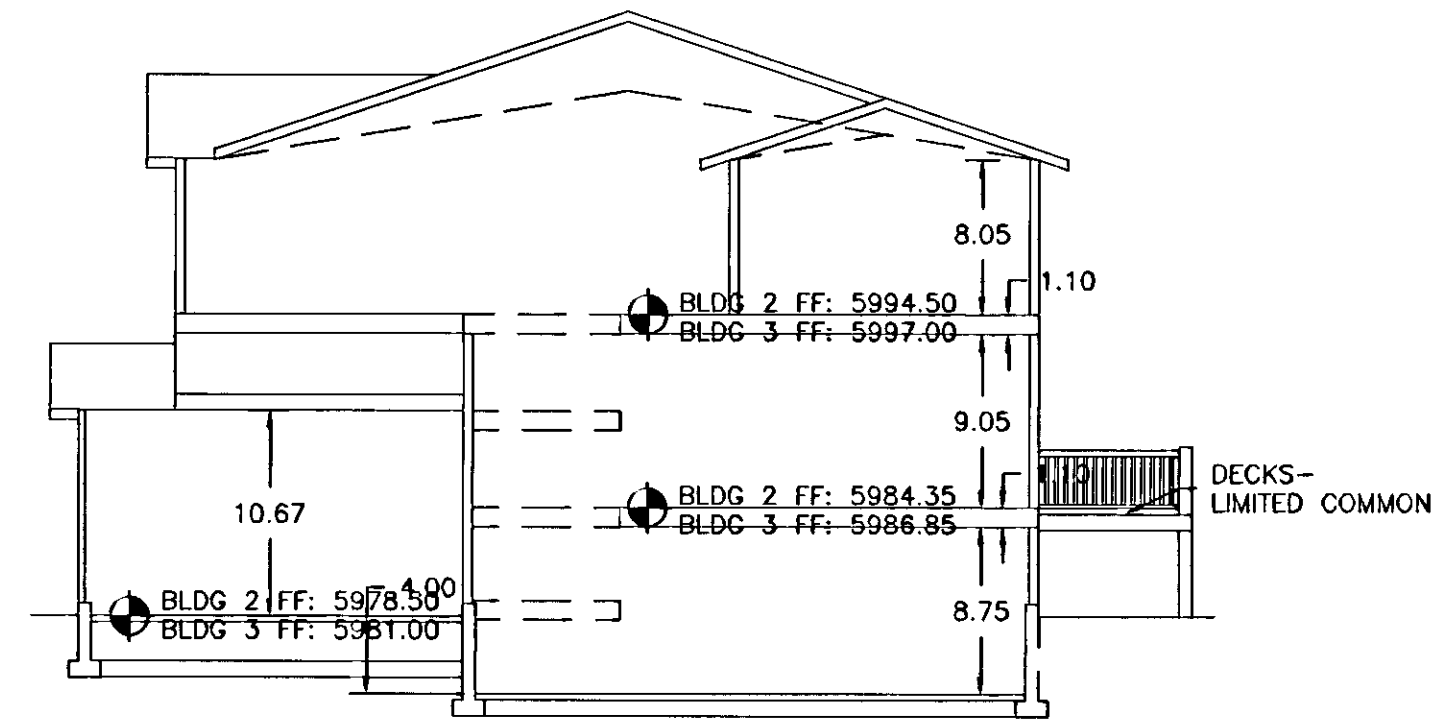

SECTION G-G
SCALE: 1"=10'

Internet Copy

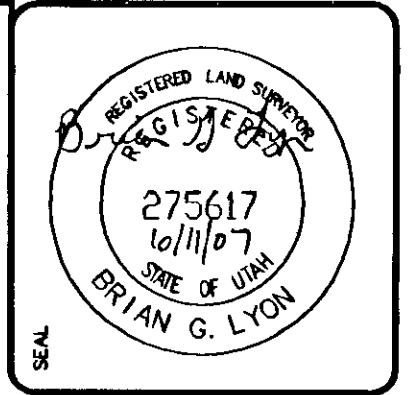

ALLIANCE CONSULTING ENGINEERS
180 WEST 200 NORTH SUITE 8
CLOAN, UTAH 84321
(435)755-5121
allianceengr@west.net

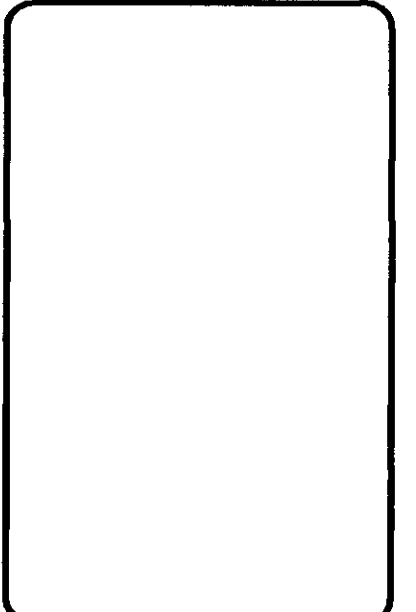

DATE	
REVISIONS / SUBMISSIONS	
NO.	
REVIEWED	
PROJECT NO.	
CAD FILE	

THE SEASONS RESORT COMMUNITY
A PLANNED UNIT DEVELOPMENT
PART OF THE NORTHWEST QUARTER OF SECTION 21,
TOWNSHIP 14 NORTH, RANGE 5 EAST,
SALT LAKE COUNTY, UTAH
GARDEN CITY, UTAH

BUILDING SECTIONS